

KAISAI

HEAT PUMPS

ENERGY-EFFICIENT SOLUTION FOR YOUR HOME AND OFFICE

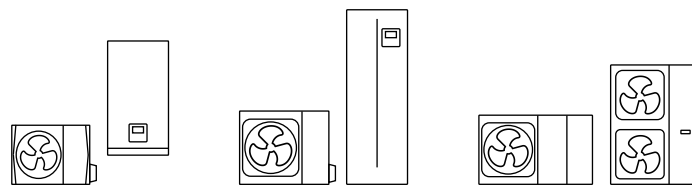

PRODUCT CATALOGUE

2022



KAISA

WE
CARE
ABOUT
AIR

KAISA

DISPLAY

MENU ON/OFF

▲ ▼

◀ ▶

OK

BACK UNLOCK

4	HOW A HEAT PUMP WORKS
6	SPLIT OR MONOBLOCK
8	ADVANTAGES OF HEAT PUMPS
18	MODERN TECHNOLOGIES
20	CONTROL
22	RANGE
24	SPLIT HEAT PUMPS
32	MONOBLOCK HEAT PUMPS
38	ACCESSORIES
40	DIMENSIONS

How a **heat pump** works

Why?

- ✓ wide range of outside temperatures
- ✓ high temperature parameters of the heating system
- ✓ high temperature parameters of the domestic hot water

For whom?

- ✓ for anyone building a house
- ✓ for those replacing or retrofitting an existing heat source
- ✓ suitable for single-family, multifamily and commercial buildings

Benefits

- ✓ zero-emission energy production
- ✓ safety of use
- ✓ maintenance-free and reliable unit

Heat pump: a renewable energy source

The heat pump draws free energy from the air and uses it to heat and cool the building, or prepare domestic hot water. It is a cheap, ecological and reliable heat source, which can be used by anyone.

Thanks to cutting-edge technology, Kaisai heat pumps operate in a wide range of outside temperatures and achieve the high temperature parameters of the heating system or domestic hot water. No emission of harmful substances into the environment, operational safety, and maintenance-free make the Kaisai heat pumps an ideal solution for everyone who builds a house as well as replaces or retrofits the current heat source. The Kaisai heat pumps can be used in single-family, multifamily, and commercial buildings.

Renewable energy sources (RES) are based on natural resources, the extraction of which ensures not only zero-emission energy production but also a wide range of possibilities for its use. Due to relatively easy access to technology and the possibility for it to be used by companies and individual households, the most popular solutions are the units which obtain energy from the air and the sun.

Kaisai's product range provides state-of-the-art RES solutions that include air-to-water heat pumps, heat recovery units, and photovoltaic modules and inverters.

Two heating circuits

Zoning provides greater control flexibility. Controlling two heating circuits allows more precise temperature control. Mixed heating, based on both radiators and underfloor heating, is still very popular. All Kaisai heat pumps come with a controller for mixing group operation as a standard. The heat pump controller controls the temperature of the radiator heating (or fan-coil units) and the underfloor heating independently. Ready-to-connect, quick to install and aesthetically pleasing mixing and pump groups are available as additional accessories.

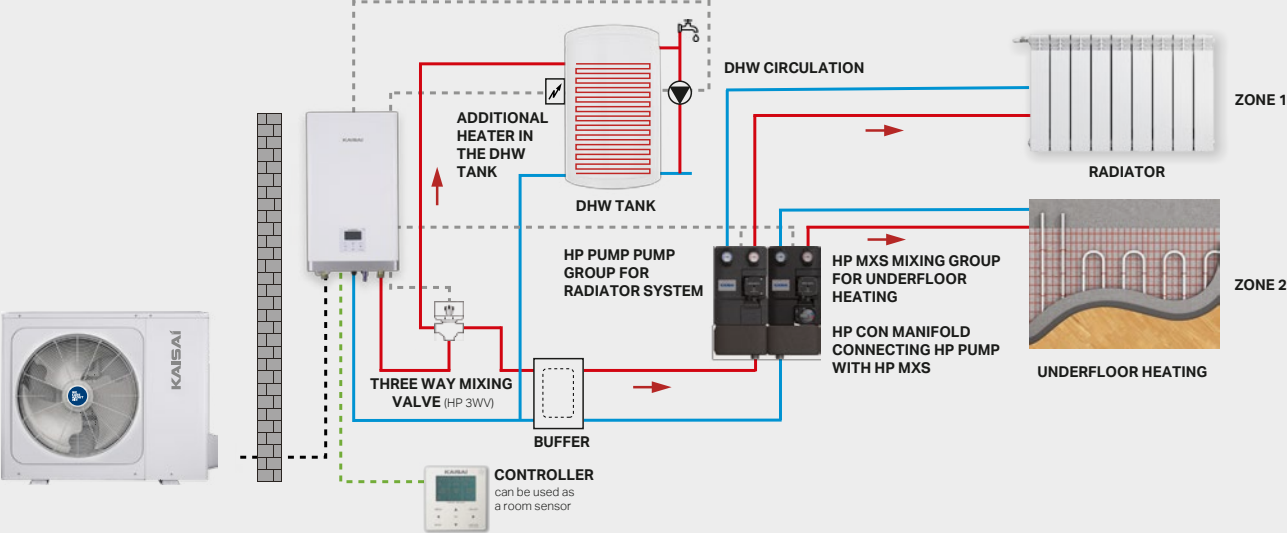

- ZONE 1** control based on leaving water temperature or heating curve
- ZONE 2** control based on leaving water temperature, heating curve or room temperature



Split or monoblok

Split

**SPLIT IS A SET OF: OUTDOOR UNIT
AND INDOOR UNIT**

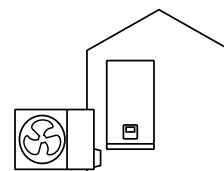

The design of the device, consisting of an indoor and outdoor unit, requires specialist installation carried out by an installer qualified to work with refrigerant gases. The advantage of this solution is that there is no risk of the heating medium freezing in case of power failure. Unlike monoblock pumps, the unit outside the building uses non-freezing refrigerant.



Prevalence of Split

NO RISK OF THE HEATING MEDIUM FREEZING

OUTDOOR UNIT REQUIRING LESS SPACE

EASIER ACCESS TO HYDRAULIC COMPONENTS

**POSSIBLE INSTALLATION OF THE HYDRAULIC
MODULE UP TO 30 M FROM THE OUTDOOR UNIT**



Monoblok

MONOBLOCK CONSIST ONLY OF ONE OUTDOOR UNIT

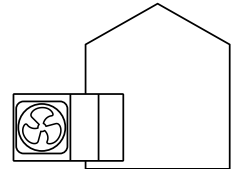

It is a compact, easy to install solution, which saves space inside the building. The user receives a complete, hermetic, ready-to-operate device, which does not require installation of a cooling system and specialist inspections. This solution is related to the necessity of securing the heating medium (water) against freezing in case of power failure.



Prevalence of Monoblock

NO SPECIFIC F-GAS AUTHORISATIONS REQUIRED

SAVING OF SPACE INSIDE THE BUILDING DUE TO LACK OF HYDRAULIC MODULE

SIMPLE INSTALLATION

HYDRAULIC READINESS FOR INTEROPERATION WITH CENTRAL HEATING



Advantage of our heat pumps

Large selection of units **and heating capacities**

Kaisai's latest product range includes 14 heat pump models, including eight monoblock units (from 6 kW to 30 kW) and six split models (from 6 kW to 16 kW), for which six indoor units are provided with or without domestic water tank (190 l or 240 l).

- 23 different sets of devices, customisable to individual needs.
- When the required heating capacity exceeds 30 kW, the heat pumps can be combined into cascades (up to 6 units) for a total capacity of up to 180 kW.
- The use of Modbus communication makes it possible to connect up to 16 devices.
- Cascade connection and Modbus function come as standard, that is why no additional accessories are required for installation.

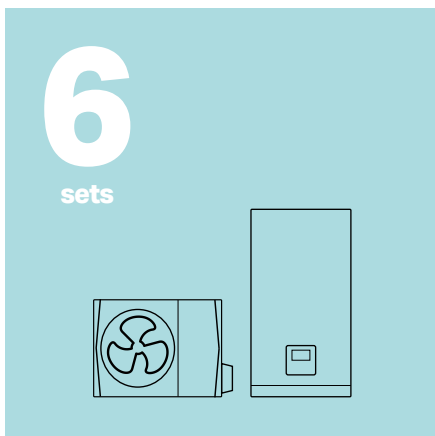

Split
from 6 to 16 kW



Split + CWU
190 or 240 l

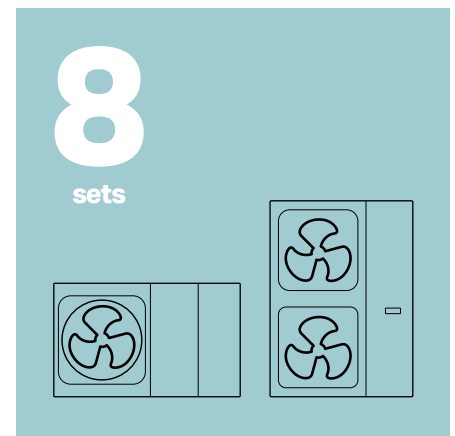

Monoblok
from 6 to 30 kW

Additional equipment for heat pumps **- more functions in the standard version**

- The hydraulic system is equipped with a circulating pump, peak heat source, safety group, flow sensor, air vent and pressure gauge as standard.
- The split indoor unit with an integrated domestic hot water tank is a complete solution for heating, cooling and preparing DHW in one compact device.
- All outdoor units have a heated drip tray as standard and monoblock models have an additional structural frame.

Economical solutions **with high parameters**



The basic criteria for selecting a heat pump, both for retrofitted and newly erected facilities, are the functionality of the devices and their high operating parameters.

By using environmentally friendly R32 refrigerant and the highest quality components, Kaisai heat pumps have a very wide operating range: outside air temperature range from -25°C to 43°C and heating medium temperature of up to 65°C.

- Possibility of heating a house equipped with traditional radiators even at very low outside temperature (at -20°C outside, the heat pump reaches a temperature of 57°C of heating system water temperature)
- The highest energy class A+++
- Extremely high efficiency: COP of 5.20 (A7W35) and SCOP of 5.22 (LWT 35°C)
- Reduced noise level: from 45 dB (A) at a distance of 1 m

Ecological **energy source**

Environmentally-friendly refrigerant, **available in the entire Kaisai range**

Kaisai heat pumps currently use the latest green refrigerant — R32. It is more efficient than those previously used, that is why less refrigerant is required. Moreover, the refrigerant has much better factors of impact on the environment. It is a modern solution taking into account both ecological needs and economy of use.

Key features of the R32 refrigerant

ECOLOGICAL

R32 has one of the lowest GWP values available on the market – 675. It also does not cause damage to the ozone layer thanks to ODP value equal to 0. Compared to older solutions, it has as much as 75% less impact on global warming. What is more, it can also be recycled.

ECONOMIC

Compared to R410A, R32 is more energy-efficient, that is why less refrigerant is required by the cooling system and equipment efficiency is increased by up to 10%.

SAFE

R32 has low toxicity and is almost non-flammable – it does not pose a threat to life and health even in case of system leaks.



Refrigerant
R32 vs R410A
75%
 less impact on global warming with R32

Energy efficiency class

Energy labels are placed on every domestic electrical appliance sold in the European Union. This is regulated by a special EU Directive 2010/30/EU. Labels inform the user about the quality of the product, taking into account, in particular, its energy efficiency. Before purchasing, the label allows everyone to compare which device will be the cheapest in terms of operation.

The ERP Directive indicates the highest possible rating for the Arctic product range.

- ηs seasonal energy efficiency of room heating up to 206%
- ηs on average up to **A+++ at 35 °C**
- ηs on average up to **A++ at 55 °C**

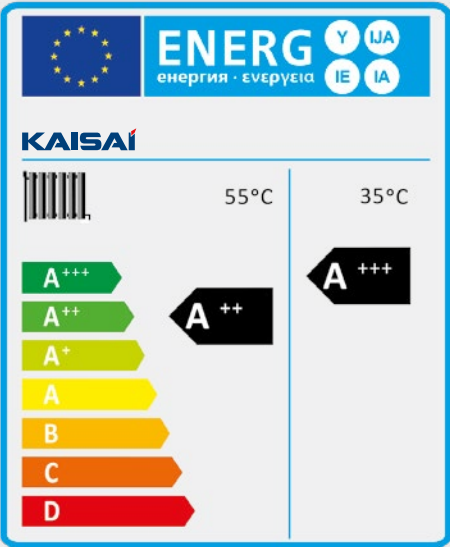

Sense of comfort



2 HEATING CIRCUITS

When the house is heated simultaneously with radiators and underfloor heating, the function allows the temperature to be precisely controlled separately for each of these heating circuits.

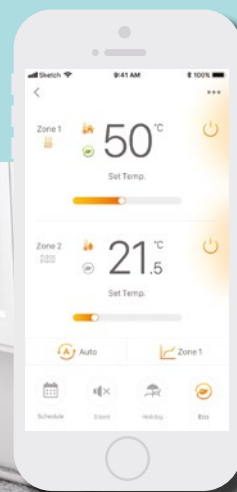

WIFI CONTROL AS STANDARD*

Kaisai products incorporate several features improving the comfort of use; for example, new control options have been added so that managing a heat pump has never been so convenient and simple.

- Remote control using an application on a smartphone or tablet
- Monitoring of current device status, zone switching, supply and domestic hot water temperature control
- Displaying error information
- Displaying current energy consumption

*BETA version of the software may not work on every device. Malfunction of the application does not constitute grounds for a complaint.



LOW NOISE LEVEL

Innovative design for lower noise level

The use of inverter compressors in outdoor units and the extremely quiet operation ensure full comfort when using the Kaisai heat pumps. The compact design of the outdoor unit with a single fan with high performance and lower noise level. The single fan design for the Mono 12~16 kW series reduces the sound power level Er_p by 6 dB. In addition, the silent mode function with two levels of operation can be used when required.



HOLIDAY PROGRAMME

While away from home for a long time, there is no need to change the weekly schedule. In the "Holiday programme" mode you can, among other things, turn off DHW heating, disinfection at a preset time interval and lower the temperature in the building. A separate "Holidays at home" function allows the schedules to be paused for the duration of a long stay at home.



WEATHER-RESPONSIVE CONTROL

Climate curves

- The water temperature is set automatically based on the outside temperature.
- 32 weather temperature curves are set as standard. Custom curves are also available to meet varying temperature requirements.

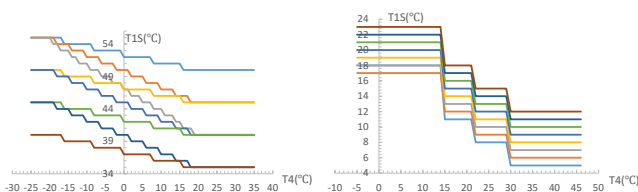

Safety of use



HEATING AND DRYING THE FLOOR

Drying mode and preheating mode protect the floor from bulges and even cracking. In newly built buildings, this mode works well right after the floor has been poured, when there is a lot of water left on the floor.



DHW TANK DISINFECTION FUNCTION

By heating the water in the system to 70°C, the high temperature kills most bacteria (including Legionella).

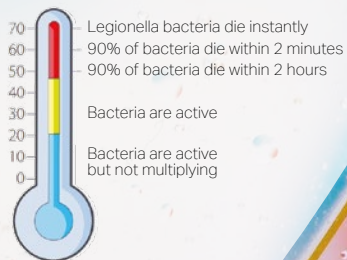



FINS WITH ANTI-CORROSION COATING

The heat exchangers use aluminium fins covered with an additional hydrophilic coating. This significantly increases their resistance to weather conditions, resulting in longer service life and lower susceptibility to corrosion.



SAFETY OF USE

The task of the intelligent automation system is to protect the heat pump against damage. The use of special explosion-proof electronic systems maximises operational safety, allowing the stable use of ecological R32 refrigerant, which is not only particularly environmentally friendly but also more efficient under extreme conditions.



OPERATION OVERVIEW

This function provides the user with a view of the basic operating parameters of the device in real-time, which in case of an error allows for a quick reaction. There are 4 operating modes: cooling, heating, DHW and auto. To meet the different requirements of users, you can combine 3 modes.



Economic solutions



HIGH ENERGY EFFICIENCY

The heat pumps are equipped with energy-efficient inverter compressors that allow variable heating capacity adjustment. This increases the efficiency of the entire system and reduces the operating costs of the pump. Kaisai heat pumps have COP of up to 5.20. The higher the coefficient, the more heat can be generated using the same amount of electricity.



POWER LIMITATION FUNCTION

The user has 8 levels to select from depending on the maximum allowable operating current. All you need to do is change the setting on the wired controller. This allows the units to be adapted to a wider range of applications.

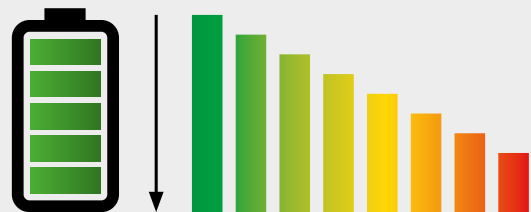



SMART GRID FUNCTION

The heat pump adapts its operation to different electric signals. The energy consumption of the system can be automatically adjusted according to peak and low power to reduce heating costs to the greatest extent possible. With this function, the pump switches on automatically to take advantage of a cheaper energy tariff or to store excess power from a photovoltaic system.



DHW mode on – tank temperature set to 70°C. The heater switches on automatically when the water temperature drops below 69°C.



Standard operation of the heat pump



Limited operation – the unit operates for a specified time and switches off.



ELECTRICITY CONSUMPTION MONITOR

This function allows the user to analyse the heat pump's electricity consumption at different time intervals and optimise its settings to save even more in terms of heating costs.*

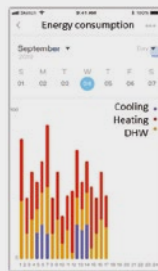

Daily electricity consumption

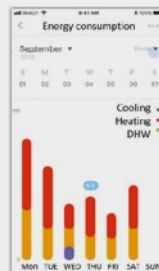

Weekly electricity consumption



Monthly electricity consumption

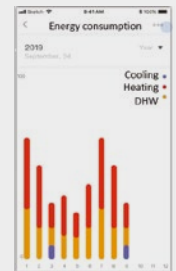

Annual electricity consumption

* BETA version of the software may not work on every device. Malfunction of the application does not constitute grounds for a complaint.

Modern technologies



INVERTER COMPRESSOR

The inverter technology in the Kaisai's units reduces power consumption, which is related to the reduction of room cooling and heating costs. Its use translates to the quiet operation of the unit and faster achievement of the desired temperature.

By using durable and high-pressure resistant materials, the compressor in Kaisai's heat pumps is extremely reliable. In addition, it has a high-efficiency motor with a wide voltage range, which is why it can operate in extreme conditions in 24-hour mode and reach temperatures of up to 65°C (voltage range from 172 to 265 V 50 Hz).



TWIN ROTARY COMPRESSOR

The high performance of compressors ensures the highest level of efficiency. The unique design minimises the vibration of moving parts, effectively reducing noise levels.

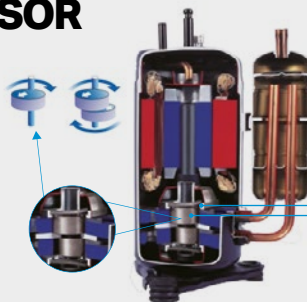

Better balance and extremely low vibrations:

- Double eccentric cams
- 2 balancing weights

Optimisation of compressor drive technology:

- Extremely robust bearings
- Compact design





DC FAN MOTOR WITH DC INVERTER

Highly efficient and quiet motors owe their characteristics to the sinusoidal control of the DC inverter. Structure optimisation provides 10% higher performance with a 35% reduction in size. Thanks to an energy-efficient motor, the units can use multiple fan speeds, which reduces energy consumption and the time needed to reach the set temperature. In turn, the use of modern technology allows for the reduction of noise levels.



USB FUNCTION

Quick setup and saving of device settings significantly shorten the heat pump setup process.



HIGH FLEXIBILITY

Thanks to the inverter technology, the heat pump adjusts the heating capacity to the demand of a specific system. Modulated heating capacity improves the unit's efficiency and operational comfort.

INNOVATIVE FAN BLADE DESIGN

Thanks to the bionic blade design it is possible to effectively reduce the air flow resistance and lower the noise level. The optimised air duct guarantees a uniform air flow and uses 30% less energy. The concave design of the suction surface reduces the size of the outgoing vortex, and the reduced weight improves performance. The edge notch changes the pressure distribution on its back edge, which in turn results in reduced noise.

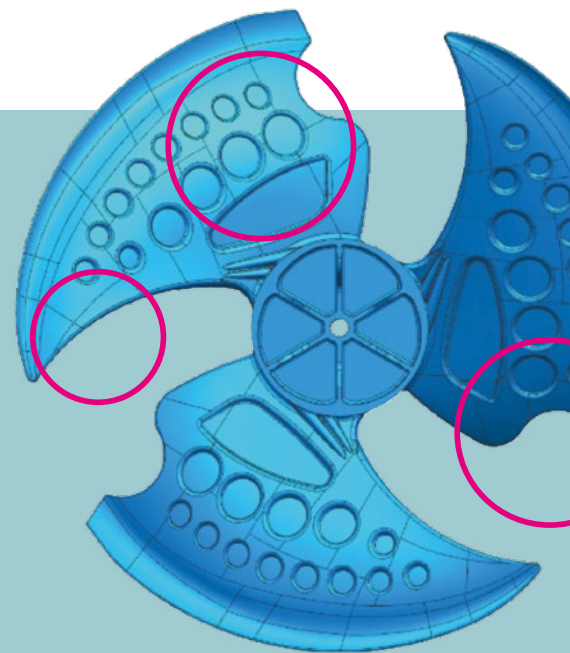

Intuitive **control**



CONTROLLER PARAMETERS AND FUNCTIONS

- Multilingual menu
- Modern controller with touch buttons
- Wireless WiFi operation*
- Modbus RTU protocol — you can connect up to 16 devices and integrate them with BMS
- Cascade configuration supports up to 6 units

- Simple and quick changing of the heat pump's operating parameters
- Real-time operation parameters monitoring
- Communication cable length up to 50 m
- Built-in temperature sensor
- Possible saving and uploading of settings via USB
- Calendar
- DHW tank disinfection function
- Fast domestic water heating function
- Silent mode, eco mode, parental control, weather-responsive control

*BETA version of the software may not work on every device.
Malfunction of the application does not constitute grounds for a complaint.

2 heating zones

Controlling two heating circuits provides greater flexibility and more accurate temperature control of the low-temperature zone. Operation of additional circulating pump and mixing valve with actuator allows precise control of the temperature of the zone with lower supply temperature e.g. underfloor heating, simultaneously supplying higher temperature to radiators.

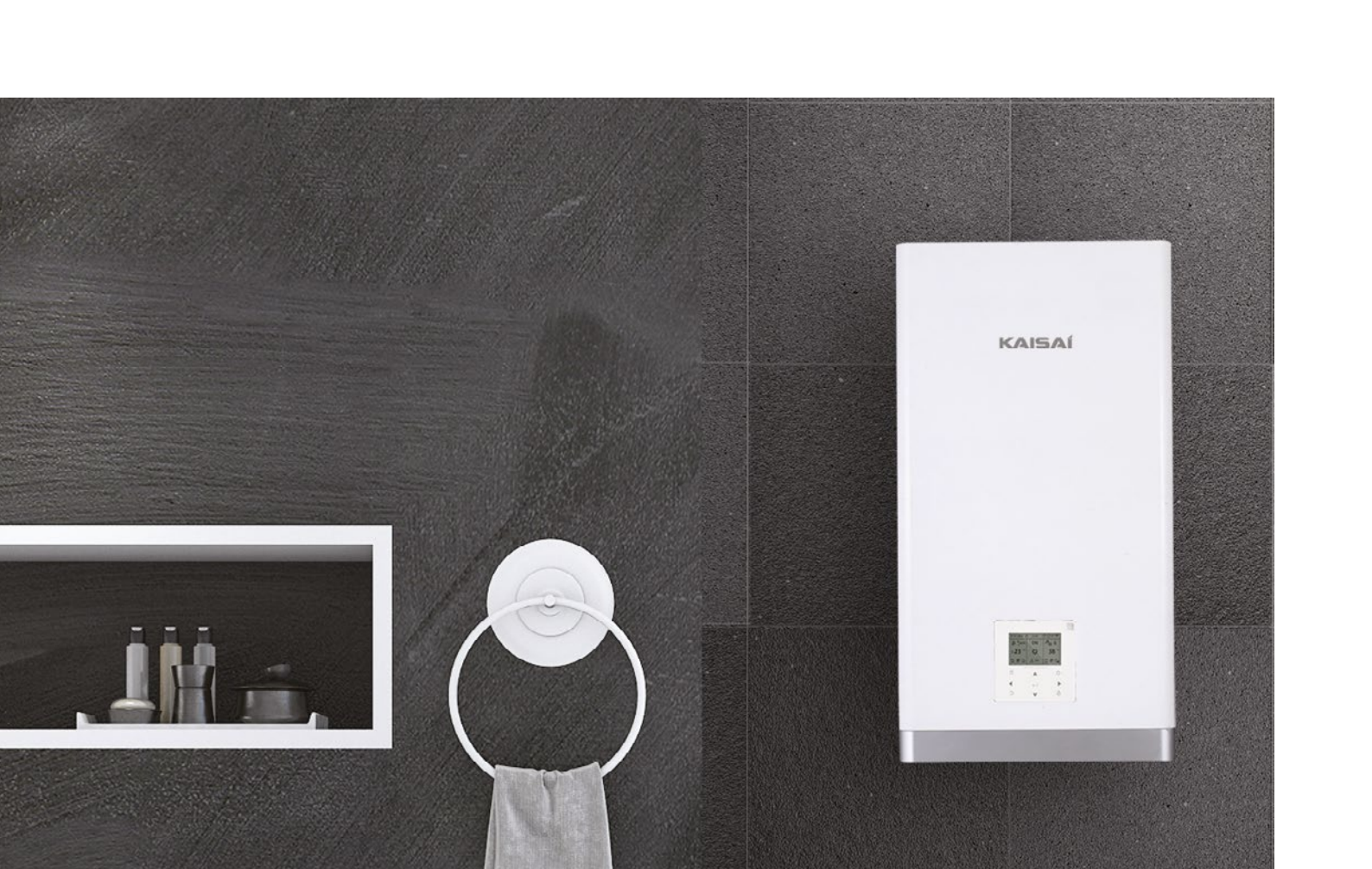

Touch-button panel



Menu Multilingual



Wi-Fi module



Built-in temperature sensor



Operating parameters monitoring



Communication cable up to 50 m



Cascade control of up to 6 units



Parental lock



Error code display



USB function



DHW tank disinfection









Weather-responsive control



Range of the devices



CAPACITY (kW) A7W35	6	8
SPLIT WITHOUT DHW TANK Outdoor unit Indoor unit	 KHA-06RY1-B KMK-60RY1	 KHA-08RY1-B KMK-100RY3
SPLIT WITH DHW TANK Outdoor unit Indoor unit	 KHA-06RY1-B KMK-190L-100RY1 KMK-240L-100RY3	  KHA-08RY1-B KMK-190L-100RY1 KMK-240L-100RY3
MONOBLOCK Outdoor unit	 KHC-06RY1-B	 KHC-08RY3-B



10		12		14		16		22		30	
 <p>KHA-10RY1-B KMK-100RY3</p>		 <p>KHA-12RY3-B KMK-160RY3</p>		 <p>KHA-14RY3-B KMK-160RY3</p>		 <p>KHA-16RY3-B KMK-160RY3</p>					
 <p>KHA-10RY1-B KMK-190L-100RY1</p>		 <p>KHA-10RY1-B KMK-240L-100RY3</p>		 <p>KHA-12RY3-B KMK-240L-160RY3</p>		 <p>KHA-14RY3-B KMK-240L-160RY3</p>		 <p>KHA-16RY3-B KMK-240L-160RY3</p>			
 <p>KHC-10RY3-B</p>		 <p>KHC-12RY3-B</p>		 <p>KHC-14RY3-B</p>		 <p>KHC-16RY3-B</p>		 <p>KHC-22RX3</p>		 <p>KHC-30RX3</p>	

SPLIT

heat pumps

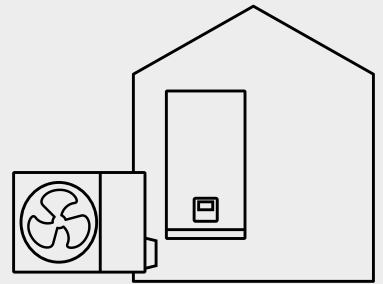

- KMK-60 RY1**
- KMK-100 | 160RY3**
- KMK-190L | 240L -100RY1(3)**
- KMK-240L-160RY3**
- KHA-06RY1-B**
- KHA-08 | 10 RY1-B**
- KHA-12 | 14 | 16 RY3-B**





A compact design, an independent indoor unit, and a flexible installation make the split type heat pump an ideal choice for owners of houses, shops, offices and retail premises.

All the hydraulic components are easily accessible. The cooling connection between the outdoor and indoor units is resistant to freezing, even during a prolonged power failure, and an additional charge of refrigerant is only required if the length of the cooling lines exceeds 15 m.

Hydraulic module



- All hydraulic components in the outdoor unit, i.e. circulating pump, expansion vessel, safety and air vent valve, flow sensor, pressure gauge and water flow heater, are fitted as standard.
- Built-in controller, possibility to move the wired controller to another location
- Easy installation and simple maintenance

KMK-60RY1, KMK-100 | 160RY3

TECHNICAL SPECIFICATION

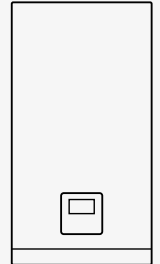

Model			KMK-60RY1	KMK-100RY3	KMK-160RY3
Names of compatible outdoor unit models			KHA-06RY1-B	KHA-08RY1-B KHA-10RY1-B	KHA-12RY3-B KHA-14RY3-B KHA-16RY3-B
Water-side heat exchanger			plate	plate	plate
Water pump	type		adjustable DC inverter	adjustable DC inverter	adjustable DC inverter
	head	m H ₂ O	9	9	9
Expansion vessel	volume	l	8	8	8
	initial pressure on the gas side	MPa	0,3	0,3	0,3
Safety valve		MPa	0,3	0,3	0,3
Flow switch		m ³ /h	0,36	0,36	0,60
Internal volume of the system, total		l	5	5	5
Power supply	voltage / number of phases / frequency	V/Ph/Hz	220÷240/1/50	380÷415/3/50	380÷415/3/50
	maximum operating current (MCA)	A	14,3	14,0	14,0
Auxiliary electric heater	electric power	kW	3	3/6/9	3/6/9
	capacity levels		1	3	3
Sound power level		dB(A)	38	42	43
Sound pressure level		dB(A)	28	30	32
Leaving water temperature (LWT)	cooling	°C	5÷25	5÷25	5÷25
	heating	°C	25÷65	25÷65	25÷65
	DHW	°C	30÷60	30÷60	30÷60
Room temperature range		°C	5÷35	5÷35	5÷35
Connection	water-side (external thread ET)	cal	1	1	1
	refrigerant liquid	mm	6,35	9,52	9,52
	refrigerant gas	mm	15,88	15,88	15,88
Dimensions	of the unit (W×H×L)	mm	420×790×270	420×790×270	420×790×270
	of the packaging (W×H×L)	mm	525×1050×360	525×1050×360	525×1050×360
Weight	net / in packaging	kg	37 / 43	37 / 43	39 / 45

The technical data above is compliant with the guidelines specified in the following standards: EN16147/2017; EN14511/2018; EN14825/2018; EU No.: 811/2013
The sound power level in the heating mode was determined in accordance with EN 12102, under the conditions consistent with EN 14825;

DHW – domestic hot water LWT - leaving water temperature

Hydraulic module with DHW tank



- The most compact design in the Kaisai heat pump range: hydraulic module + DHW tank in one
- A complete unit for central heating and DHW operation
- The footprint area is only 0.36 m²
- Built-in three way valve and an auxiliary heater
- DHW tank available in two sizes: 190 L and 240 L
- Built-in controller

KMK-190L-100RY1, KMK-240L-100/160RY3

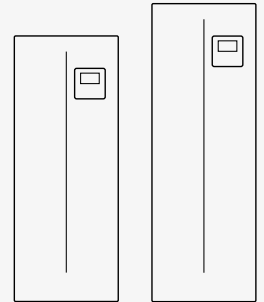

TECHNICAL SPECIFICATION

Model		KMK-190L-100RY1		KMK-240L-100RY3		KMK-240L-160RY3		
Names of compatible outdoor unit models		KHA-06RY1-B	KHA-08RY1-B KHA-10RY1-B	KHA-06RY1-B	KHA-08RY1-B KHA-10RY1-B	KHA-12RY3-B KHA-14RY3-B KHA-16RY3-B		
Heat exchanger		plate						
Water pump	type	DC Inverter						
	head	m H2O	9	9	9	9	9	
Expansion vessel		volume	l	8	8	8	8	
Water consumption profile acc. to EN16147			L	L	XL	XL	XL	
Domestic hot water 1	energy efficiency class for DHW heating	temperate climate	class	A+	A+	A+	A+	A+
			COP	3,10	3,02	3,34	3,36	3,00
		warm climate	class	A+	A+	A+	A+	A+
			COP	3,80	3,66	4,24	4,18	3,73
		cold climate	class	A	A	A	A	A
			COP	2,50	2,61	2,63	2,72	2,24
DHW tank	type	stainless steel						
	material	SUS 316L						
	water capacity	L	190	190	240	240	240	
	maximum water temperature	°C	70	70	70	70	70	
	insulation (material)	poliuretan (cyklopentan)						
Electric power supply	voltage / number of phases / frequency	V/Ph/Hz	220÷240/1/50		380÷415/3/50		380÷415/3/50	
	maximum operating current (MCA)	A	14,3	14,3	14,3	14,3	14,3	
Auxiliary electric heater	electric power	kW	3	3	3/6/9	3/6/9	3/6/9	
	capacity levels		1	1	3	3	3	
	power supply	V/Ph/Hz	220÷240/1/50		380÷415/3/50		380÷415/3/50	
Sound power level		dB	38	40	38	40	44	
Temperature range	indoor	°C	5÷35	5÷35	5÷35	5÷35	5÷35	
	heating	°C	25÷65	25÷65	25÷65	25÷65	25÷65	
	cooling	°C	5÷25	5÷25	5÷25	5÷25	5÷25	
	domestic hot water (DHW)	°C	30÷60	30÷60	30÷60	30÷60	30÷60	
Water connection	heating system (external thread ET)	supply/return	cal	1	1	1	1	
	DHW (external thread ET)	cold water circulation hot water	cal	3/4	3/4	3/4	3/4	
Dimensions	of the unit (W×H×L)	mm	600x1683x600			600x1943x600		
	of the packaging (W×H×L)	mm	653x1900x653			653x2160x653		
Weight	net / in packaging	kg	138,6 / 153,8		155,3 / 170,2		157,3 / 172,2	

The technical data above is compliant with the guidelines specified in the following standards: EN16147/2017; EN14511/2018; EN14825/2018; EU No.: 811/2013
The sound power level in the heating mode was determined in accordance with EN 12102, under the conditions consistent with EN 14825;

Outdoor units

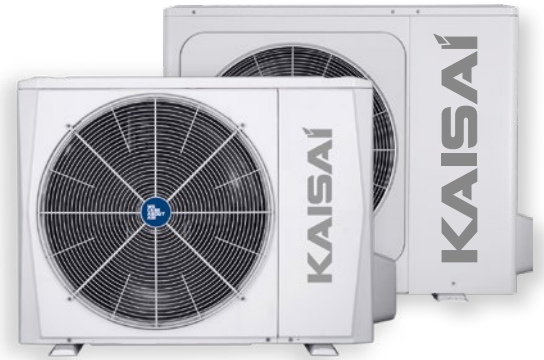

- Compact design, independent hydraulic module, and flexible installation
- The cooling connection between the outdoor and indoor units is resistant to freezing, even during a prolonged power failure
- An additional charge of refrigerant is only required if the length of the cooling lines exceeds 15 m.
- Built-in drip tray with heater

KHA-06 | 08 | 10RY1-B, KHA-12 | 14 | 16RY3-B

TECHNICAL SPECIFICATION

Model			KHA-06RY1-B	KHA-08RY1-B	KHA-10RY1-B	KHA-12RY3-B	KHA-14RY3-B	KHA-16RY3-B
Heating A7W35 ΔT=5, R.H. 85%	nominal heat capacity (range)	kW	6,20 (2,73÷7,41)	8,30 (3,36÷9,11)	10,00 (3,81÷10,30)	12,10 (5,58÷14,60)	14,50 (5,92÷15,50)	16,00 (6,43÷16,80)
	electric energy consumption (range)	kW	1,24 (0,53÷1,56)	1,60 (0,61÷1,80)	2,00 (0,71÷2,09)	2,44 (1,04÷3,11)	3,09 (1,12÷3,37)	3,56 (1,27÷3,79)
	COP (range)	W/W	5,00 (5,32÷4,76)	5,20 (5,54÷5,07)	5,00 (5,39÷4,93)	4,95 (5,38÷4,69)	4,70 (5,27÷4,59)	4,50 (5,08÷4,43)
Heating A2W35 ΔT=5, R.H. 85%	nominal heat capacity	kW	5,50	7,10	8,20	9,30	11,40	13,00
	electric power consumption	kW	1,39	1,73	2,02	2,35	3,12	3,71
	COP	W/W	3,95	4,10	4,05	3,95	3,65	3,50
Heating A-7W35 ΔT=5, R.H. 85%	nominal heat capacity (range)	kW	6,10(1,48÷6,21)	7,10(1,82÷7,27)	8,25(2,05÷8,31)	10,00(3,97÷11,00)	12,00(4,57÷12,70)	13,30(4,99÷13,90)
	electric energy consumption (range)	kW	2,00 (0,48÷2,17)	2,18 (0,53÷2,26)	2,62 (0,61÷2,61)	3,33 (1,26÷3,89)	4,29 (1,48÷4,55)	4,93 (1,68÷5,19)
	COP (range)	W/W	3,05(3,06÷2,86)	3,25(3,44÷3,21)	3,15(3,37÷3,11)	3,00(3,14÷2,83)	2,80(3,10÷2,79)	2,70(2,97÷2,67)
Cooling A35W18 ΔT=5	nominal cooling capacity	kW	6,55	8,40	10,00	12,00	13,50	14,90
	electric power consumption	kW	1,34	1,66	2,08	3,00	3,75	4,38
	EER	W/W	4,90	5,05	4,80	4,00	3,60	3,40
Cooling A35W7 ΔT=5	nominal cooling capacity	kW	7,00	7,40	8,20	11,60	12,70	14,00
	electric power consumption	kW	2,33	2,19	2,48	4,22	4,98	5,71
	EER	W/W	3,00	3,38	3,30	2,75	2,55	2,45
Seasonal energy efficiency rating for room heating	LWT at 35°C (temperate climate zone)	klasa	A+++	A+++	A+++	A+++	A+++	A+++
	LWT at 55°C (temperate climate zone)	klasa	A++	A++	A++	A++	A++	A++
SCOP	LWT at 35°C		4,95	5,21	5,19	4,81	4,72	4,62
	LWT at 55°C		3,52	3,36	3,49	3,45	3,47	3,41
Power supply	voltage / number of phases / frequency	V/Ph/Hz	220÷240/1/50	220÷240/1/50	220÷240/1/50	380÷415/3/50	380÷415/3/50	380÷415/3/50
	maximum operating current (MCA)	A	14	16	17	10	11	12
Sound level	sound power level (acc. to EN 12102)	dB	58	59	60	64	65	68
	acoustic pressure (1m)	dB	45	46	49	50	51	55
Outside air temperature range	cooling	°C	-5÷43	-5÷43	-5÷43	-5÷43	-5÷43	-5÷43
	heating	°C	-25÷35	-25÷35	-25÷35	-25÷35	-25÷35	-25÷35
	CWU	°C	-25÷43	-25÷43	-25÷43	-25÷43	-25÷43	-25÷43
Compressor type	twin rotary	DC	DC	DC	DC	DC	DC	
Cooling system	liquid / gas line diameters	mm	6,35 / 15,88	9,52 / 15,88	9,52 / 15,88	9,52 / 15,88	9,52 / 15,88	9,52 / 15,88
		cal	1/4 / 5/8	3/8 / 5/8	3/8 / 5/8	3/8 / 5/8	3/8 / 5/8	3/8 / 5/8
	permissible system length / permissible height difference	m	2÷30 / 20	2÷30 / 20	2÷30 / 20	2÷30 / 20	2÷30 / 20	2÷30 / 20
	connection method		socket	socket	socket	socket	socket	socket
Additional refrigerant	charge	g/m	20	38	38	38	38	38
	length without charge	m	<15	<15	<15	<15	<15	<15
Refrigerant	symbol (GWP) / refrigerant amount	kg	R32 (675) / 1,5	R32 (675) / 1,65	R32 (675) / 1,65	R32 (675) / 1,84	R32 (675) / 1,84	R32 (675) / 1,84
	of the unit (W×H×L)	mm	1008×712×426			1118×865×523		
Dimensions	of the packaging (W×H×L)	mm	1065×800×485			1180×890×560		
Weight	net / in packaging		58 / 64	75 / 89	75 / 89	112 / 125	112 / 125	112 / 125

The technical data above is compliant with the guidelines specified in the following standards: EN14511; EN14825; EN50564; EN12102; (EU) No. 811:2013; (EU) No. 813:2013; OJ 2014/C 207/02:2014. The SCOP seasonal heating efficiency was determined for temperate climate conditions.
The sound power level in the heating mode was determined in accordance with EN 12102, under the conditions consistent with EN 14825;

MONOBLOCK

heat pumps

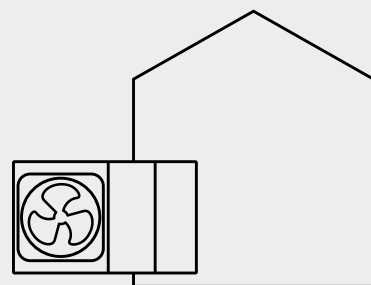

KHC-06RY1-B

KHC-08 | 10 | 12 | 14 | 16RY3-B

KHC-22 | 30RX3





In the monoblock heat pumps, the refrigerant system is completely integrated within the outdoor unit. First and foremost, such a solution ensures no need to hold special authorisations in terms of cooling systems, space-saving and quiet unit operation.

The special design allows easy access to the internal components, while the length of the communication cable of up to 50 m provides great freedom, in terms of installing the controller.

Outdoor units

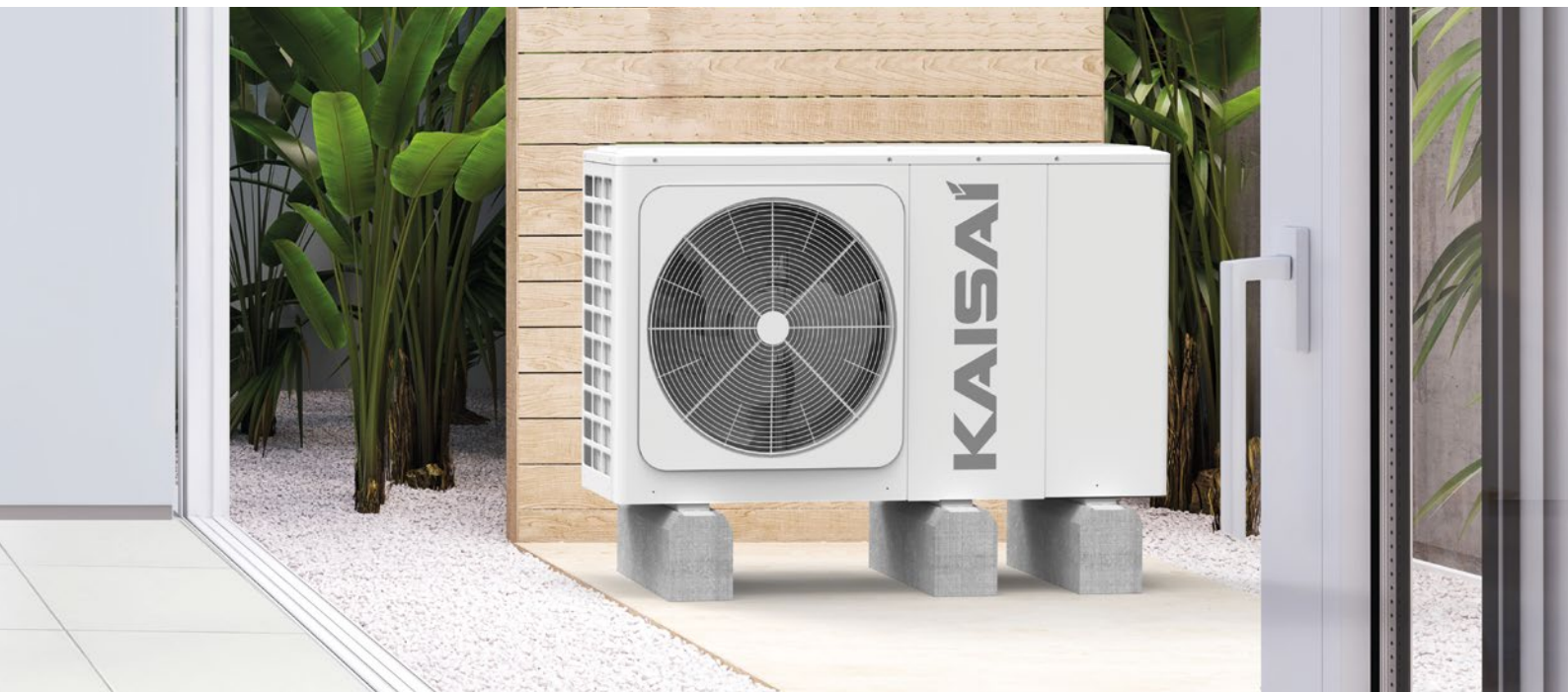

- Easy installation and simple maintenance
- All hydraulic components in the outdoor unit: i.a.: circulating pump, expansion vessel, safety and air vent valve, flow sensor, pressure gauge and water flow heater, are fitted as standard.
- The cooling system is fully integrated in the outdoor unit, which means that no additional freon lines are required.
- Compact design, easy to transport and install



KHC-06RY1-B

TECHNICAL SPECIFICATION

Model		KHC-06RY1-B	
Heating A7W35 ΔT=5, R.H. 85%	nominal heat capacity (range)	kW	6,35 (2,73÷7,41)
	electric energy consumption (range)	kW	1,28 (0,53÷1,56)
	COP (range)	W/W	4,95 (5,32÷4,76)
Heating A2W35 ΔT=5, R.H. 85%	nominal heat capacity	kW	5,50
	electric power consumption	kW	1,41
	COP	W/W	3,90
Heating A-7W35 ΔT=5, R.H. 85%	nominal heat capacity (range)	kW	6,00 (1,48÷6,21)
	electric energy consumption (range)	kW	2,00 (0,48÷2,17)
	COP (range)	W/W	3,00 (3,06÷2,86)
Cooling A35W18 ΔT=5	nominal cooling capacity	kW	6,50
	electric power consumption	kW	1,35
	EER	W/W	4,80
Cooling A35W7 ΔT=5	nominal cooling capacity	kW	7,00
	electric power consumption	kW	2,33
	EER	W/W	3,00
Seasonal energy efficiency rating for room heating	LWT at 35°C class (temperate climate zone)	class	A+++
	LWT at 55°C class (temperate climate zone)	class	A++
SCOP	LWT at 35°C	W/W	4,95
	LWT at 55°C	W/W	3,52
Power supply	voltage / number of phases / frequency	V/Ph/Hz	220÷240/1/50
	maximum operating current (MCA)	A	27
Auxiliary electric heater	electric power	kW	3
	capacity levels		1
Sound level	sound power level	dB(A)	58
	acoustic pressure (1 m)	dB(A)	45
Outside air temperature range	cooling	°C	-5÷43
	heating	°C	-25÷35
	DHW	°C	-25÷43
Leaving water temperature range	cooling	°C	5÷25
	heating	°C	25÷65
	DHW	°C	20÷60
Water connection	diameter	cal	external thread G1
Refrigerant	symbol (GWP) / refrigerant amount	--- / kg	R32 (675) / 1,4
	of the unit (W×H×L)	mm	1295×718×429
Dimensions	of the packaging (W×H×L)	mm	1375×885×475
	Weight	net / in packaging	kg

The technical data above is compliant with the guidelines specified in the following standards: EN14511; EN14825; EN50564; EN12102; (EU) No. 811:2013; (EU) No. 813:2013; OJ 2014/C 207/02:2014. The SCOP seasonal heating efficiency was determined for temperate climate conditions.
The sound power level in the heating mode was determined in accordance with EN 12102, under the conditions consistent with EN 14825;



KHC-08 | 10 | 12 | 14 | 16RY3

TECHNICAL SPECIFICATION

Model		KHC-08RY3-B	KHC-10RY3-B	KHC-12RY3-B	KHC-14RY3-B	KHC-16RY3-B	
Heating A7W35 ΔT=5, R.H. 85%	nominal heat capacity (range)	kW	8,40 (3,36÷9,11)	10,00 (3,81÷10,3)	12,10 (5,58÷14,6)	14,50 (5,92÷15,50)	15,90 (6,43÷16,80)
	electric energy consumption (range)	kW	1,63 (0,61÷1,80)	2,02 (0,71÷2,09)	2,44 (1,04÷3,11)	3,15 (1,12÷3,37)	3,53 (1,27÷3,79)
	COP (range)	W/W	5,15 (5,54÷5,07)	4,95 (5,39÷4,93)	4,95 (5,38÷4,69)	4,60 (5,27÷4,59)	4,50 (5,08÷4,43)
Heating A2W35 ΔT=5, R.H. 85%	nominal heat capacity	kW	7,10	8,20	9,20	11,00	13,00
	electric power consumption	kW	1,73	2,05	2,36	3,06	3,77
	COP	W/W	4,10	4,00	3,90	3,60	3,45
Heating A-7W35 ΔT=5, R.H. 85%	nominal heat capacity (range)	kW	7,00 (1,82÷7,27)	8,00 (2,05÷8,31)	10,00 (3,97÷11,00)	12,00 (4,57÷12,70)	13,10 (4,99÷13,90)
	electric energy consumption (range)	kW	2,19 (0,53÷2,26)	2,62 (0,61÷2,61)	3,33 (1,26÷3,89)	4,21 (1,48÷4,55)	4,85 (1,68÷5,19)
	COP (range)	W/W	3,26 (3,44÷3,21)	3,05 (3,37÷3,11)	3,00 (3,14÷2,83)	2,85 (3,10÷2,79)	2,70 (2,97÷2,67)
Cooling A35W18 ΔT=5	nominal cooling capacity	kW	8,30	9,90	12,00	13,50	14,90
	electric power consumption	kW	1,64	2,18	3,04	3,75	4,38
	EER	W/W	5,05	4,55	3,95	3,60	3,40
Cooling A35W7 ΔT=5	nominal cooling capacity	kW	7,45	8,20	11,50	12,40	14,00
	electric power consumption	kW	2,22	2,52	4,18	4,96	5,60
	EER	W/W	3,35	3,25	2,75	2,50	2,50
Seasonal energy efficiency rating for room heating	LWT at 35°C class (temperate climate zone)	klasa	A+++	A+++	A+++	A+++	A+++
	LWT at 55°C class (temperate climate zone)	klasa	A++	A++	A++	A++	A++
SCOP	LWT at 35°C	W/W	5,22	5,20	4,81	4,72	4,62
	LWT at 55°C	W/W	3,37	3,47	3,45	3,47	3,41
Power supply	voltage / number of phases / frequency	V/Ph/Hz	380÷415/3/50	380÷415/3/50	380÷415/3/50	380÷415/3/50	380÷415/3/50
	maximum operating current (MCA)	A	29	30	23	24	25
Auxiliary electric heater	electric power	kW	3/6/9	3/6/9	3/6/9	3/6/9	3/6/9
	capacity levels		3	3	3	3	3
Sound level	sound power level	dB(A)	59	60	65	65	68
	acoustic pressure (1 m)	dB(A)	46	49	50	51	55
Outside air temperature range	cooling	°C	-5÷43	-5÷43	-5÷43	-5÷43	-5÷43
	heating	°C	-25÷35	-25÷35	-25÷35	-25÷35	-25÷35
	DHW	°C	-25÷43	-25÷43	-25÷43	-25÷43	-25÷43
Leaving water temperature range	cooling	°C	5÷25	5÷25	5÷25	5÷25	5÷25
	heating	°C	25÷65	25÷65	25÷65	25÷65	25÷65
	DHW	°C	20÷60	20÷60	20÷60	20÷60	20÷60
Water connection	diameter	cal	external thread G5/4				
Refrigerant	symbol (GWP) / refrigerant amount	--- / kg	R32 (675) / 1,4	R32 (675) / 1,4	R32 (675) / 1,75	R32 (675) / 1,75	R32 (675) / 1,75
	of the unit (W×H×L)	mm	1385×865×526				
Dimensions	of the packaging (W×H×L)	mm	1465×1035×560				
	Weight	net / in packaging	kg	105 / 132	105 / 132	144 / 172	144 / 172

The technical data above is compliant with the guidelines specified in the following standards: EN14511; EN14825; EN50564; EN12102; (EU) No. 811:2013; (EU) No. 813:2013; OJ 2014/C 207/02:2014. The SCOP seasonal heating efficiency was determined for temperate climate conditions.
The sound power level in the heating mode was determined in accordance with EN 12102, under the conditions consistent with EN 14825;



KHC-22 | 30 RX3

TECHNICAL SPECIFICATION

Model			KHC-22RX3	KHC-30RX3
Heating A7W35 ΔT=5, R.H. 85%	nominal heat capacity (range)	kW	22,00 (9,92÷24,93)	30,10 (13,85÷31,75)
	electric energy consumption (range)	kW	5,00 (1,90÷6,47)	7,70 (2,93÷9,51)
	COP (range)	W/W	4,40 (5,33÷3,85)	3,91 (4,73÷3,34)
Heating A2W35 ΔT=5, R.H. 85%	nominal heat capacity	kW	22,00	26,00
	electric power consumption	kW	7,09	9,38
	COP	W/W	3,10	2,80
Heating A-7W35 ΔT=5, R.H. 85%	nominal heat capacity (range)	kW	21,00 (8,10÷23,73)	23,00 (10,35÷24,89)
	electric energy consumption (range)	kW	8,07 (2,91÷9,25)	9,38 (3,66÷9,93)
	COP (range)	W/W	2,60 (2,75÷2,56)	2,45 (2,83÷2,51)
Cooling A35W18 ΔT=5	nominal cooling capacity	kW	23,00	31,00
	electric power consumption	kW	5,00	7,75
	EER	W/W	4,60	4,00
Cooling A35W7 ΔT=5	nominal cooling capacity	kW	21,00	29,50
	electric power consumption	kW	7,12	11,57
	EER	W/W	2,95	2,55
Seasonal energy efficiency rating for room heating	LWT at 35°C class (temperate climate zone)	klasa	A+++	A++
	LWT at 55°C class (temperate climate zone)	klasa	A++	A+
SCOP	LWT at 35°C	W/W	4,53	4,19
	LWT at 55°C	W/W	3,22	3,14
Power supply	voltage / number of phases / frequency	V/Ph/Hz	380÷415/3/50	380÷415/3/50
	maximum operating current (MCA)	A	24,5	28,5
Sound level	sound power level	dB(A)	73	77
	acoustic pressure (1 m)	dB(A)	59	63
Outside air temperature range	cooling	°C	-5÷46	-5÷46
	heating	°C	-25÷35	-25÷35
	DHW	°C	-25÷43	-25÷43
Leaving water temperature range	cooling	°C	5÷25	5÷25
	heating	°C	25÷60	25÷60
	DHW	°C	30÷60	30÷60
Water connection	diameter	cal	external thread G5/4	
Refrigerant	symbol (GWP) / refrigerant amount	--- / kg	R32 (675) / 5,0	R32 (675) / 5,0
Dimensions	of the unit (W×H×L)	mm	1129×1558×440	
	of the packaging (W×H×L)	mm	1220×1735×565	
Weight	net / in packaging	kg	177 / 206	177 / 206

The technical data above is compliant with the guidelines specified in the following standards: EN14511; EN14825; EN50564; EN12102; (EU) No. 811:2013; (EU) No. 813:2013; OJ 2014/C 207/02:2014. The SCOP seasonal heating efficiency was determined for temperate climate conditions.

The sound power level in the heating mode was determined in accordance with EN 12102, under the conditions consistent with EN 14825;

Accessories



Remote Service Monitoring Module (KSM)

The Kaisai Remote Service Monitoring for heat pumps consists of a KSM module connected to the heat pump and software on a server and enables remote supervision of the unit with monitoring of its operation and quick service response in the event of a fault.

The KSM provides the ability to remotely adjust the heat pump's operating parameters and the sense of security that comes from having constant control over its operation.



REMOTE SERVICE MONITORING SCHEME

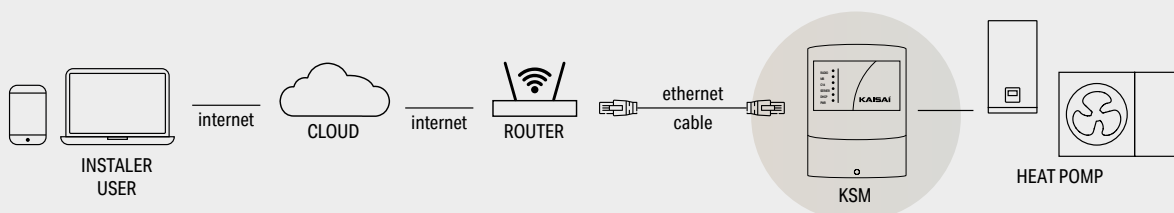



ADVANTAGES FOR THE INSTALLER:



- easy access to your own installations
- customer care
- remote problem solving
- minimise the number of field interventions
- reduction of telephone advice
- time saving

ADVANTAGES FOR THE USER:

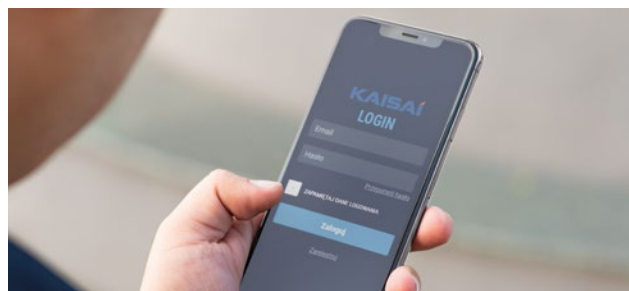

- application for IOS and Android mobile device
- insight into a wide range of heat pump operation and settings
- constant monitoring of heat pump operation by installation company
- sense of security

O T H E R A C C E S S O R I E S

Model

HP 3WV – 3-way valve for switching between central heating and DHW (dedicated to 6-10kW heat pumps)

T1/T5/Tw2/Tbt1 – Additional temperature sensor

Dimensions of the **devices**

KMK-60RY1 KMK-100 | 160RY3

1	Cooling connection – gas 5/8"
2	Cooling connection – liquid 1/4" (model 60), 3/8" (models 100/160)
3	Condensate drain $\varnothing 25$
4	Water inlet from the central heating system R1" (ET)
5	Water outlet to the central heating system R1" (ET)

A	B	C	D	E	F	G	H	I	J	K	L	M	N	O
721	158	824	790	216	60	68	151	49	82	53	149	50	40	152

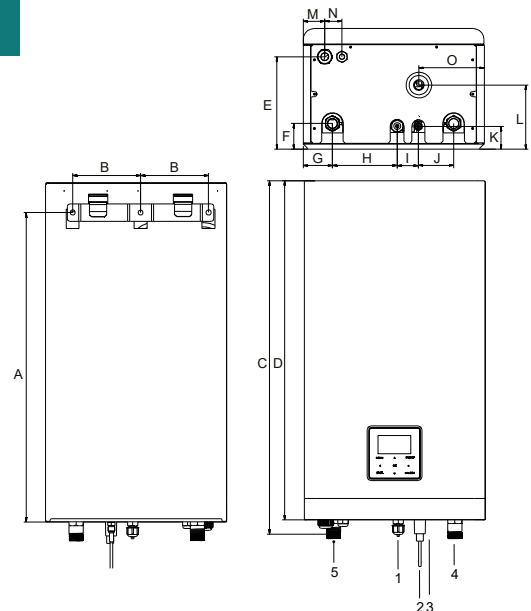

KMK-190L-100RY1 KMK-240L-100/160RY3

1	Cooling connection – gas 5/8"
2	Cooling connection – liquid 3/8"
3	Domestic hot water outlet
4	Domestic hot water recirculation inlet (plugged with screw plug)
5	Domestic cold water inlet
6	Water inlet from the central heating system R1" (ET)
7	Water outlet to the central heating system R1" (ET)
8	Condensate drain $\varnothing 25$
9	Circulation outlet from the solar collector system (non-standard)
10	Circulation inlet from the solar collector system (non-standard)

MODEL	A	B	C	D
KMK-190L-100 RY1	600	600	1711	1774
KMK-240L-100 RY1/ KMK-100-160 RY3	600	600	1971	2034

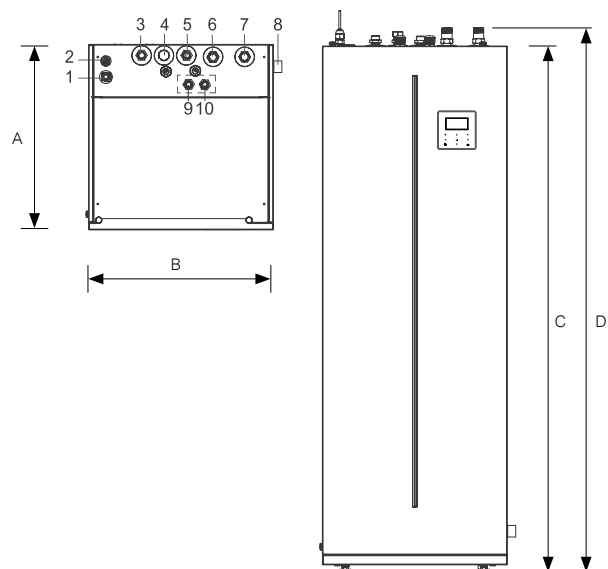

KHA-06RY1-B

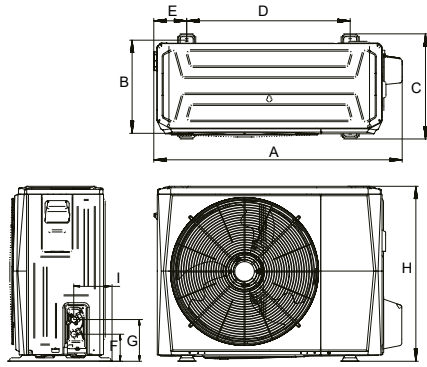

KHA-08 | 10RY1-B KHA-12 | 14 | 16RY3-B

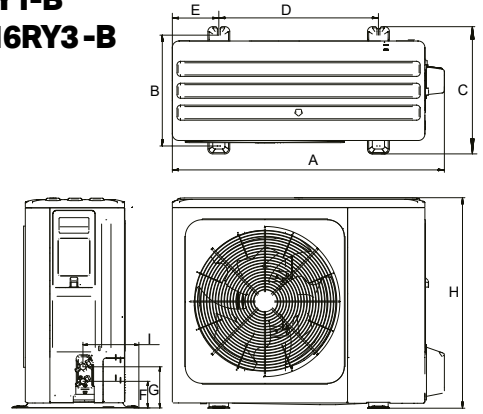

MODEL	A	B	C	D	E	F	G	H	I
KHA-06RY1	1008	375	426	663	134	110	170	712	160
KHA-08/10RY1	1118	456	523	656	191	110	170	865	230
KHA-12/14/16RY3	1118	456	523	656	191	110	170	865	230

KHC-06RY1-B

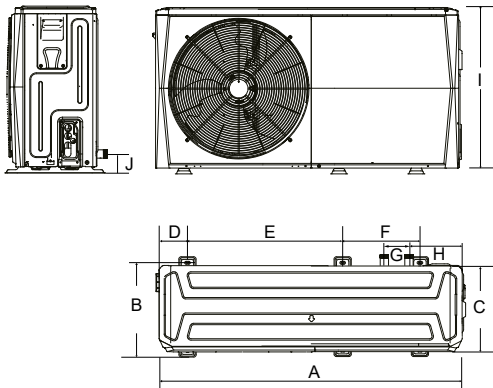

KHC-08 | 10 | 12 | 14 | 16RY3-B

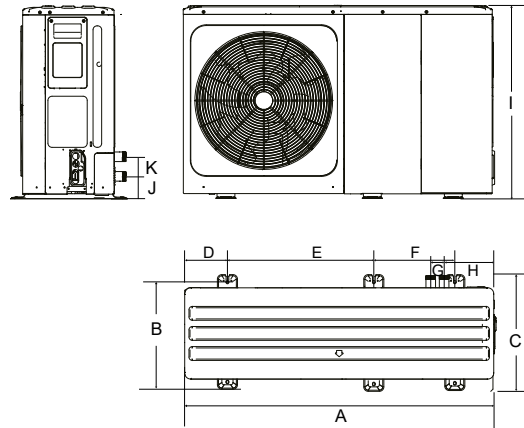

MODEL	A	B	C	D	E	F	G	H	I	J	K
KHC-06RY1	1295	401	429	115	638	379	105	225	718	161	/
KHC-08/10/12/14/16RY3	1385	488	526	192	656	363	60	221	865	182	81

KHC-22 | 30 RX3

A	B	C	D	E	F	G	H	I	J	K	L
1129	494	528	668	192	98	206	1558	558	143	400	440

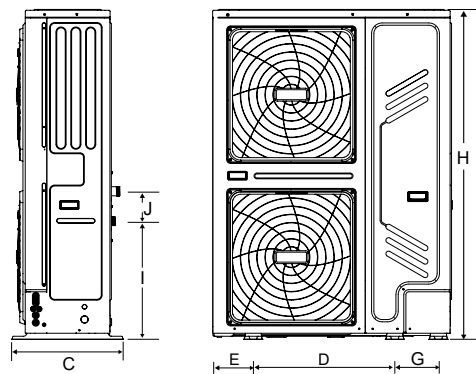
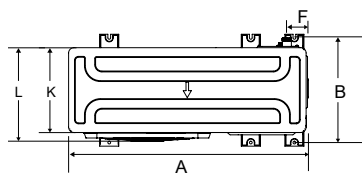

Kaisai Products: **Caring about environment**



HEAT PUMPS

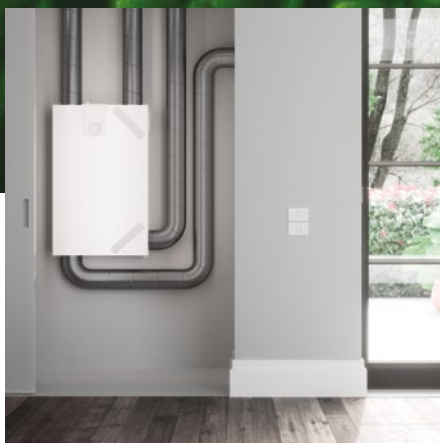

HEAT RECOVERY UNITS



**PHOTOVOLTAIC MODULES
AND INVERTERS**

**Full range of products based on renewable
energy sources available on our website**

 **kaisai.com**

Contact details

For Consumers:

Are you interested in buying our products?

Check the current list of Distributors in Poland at: www.kaisai.com

For Distributors and Installers:

HEADQUARTERS

ul. Ostrobramska 101A
04-041 Warsaw
22 517 36 00 | 22 879 99 07

SALES DEPARTMENT

22 465 65 85
handlowy@kaisai.com

Do you want to become our Distributor? Write or call us.

Klima-Therm Group Academy:

GDAŃSK BRANCH

ul. Budowlanych 48
80-298 Gdańsk
58 768 03 33

WARSAW BRANCH

ul. Ostrobramska 101A
04-041 Warsaw
22 517 36 00

KATOWICE BRANCH

ul. Chorzowska 108, Budynek B
40-101 Katowice
32 209 49 26

Do you want to obtain an authorisation certificate and become our Installer?

Contact us: handlowy@kaisai.com

The purpose of this document is to provide information and present heat pumps of the Kaisai brand. | Since the technologically advanced production process necessitates its continuous control and improvement, the information contained in this publication may be subject to change. The technical data and prices included in the folder are subject to change. Up-to-date information is always available on www.kaisai.com

All technical data is compliant with the guidelines specified in the following standards: EN14511; EN14825; EN50564; EN12102; (EU) No. 811:2013; (EU) No. 813:2013; OJ 2014/C 207/02:2014. The SCOP seasonal heating efficiency was determined for temperate climate conditions. The sound power level in the heating mode was determined in accordance with EN 12102, under the conditions consistent with EN 14825.



kaisai.com